



# User's Guide



## Adash 4900 – Vibrio III

- 📁 Machine vibration diagnostics
  - 📁 Bearing diagnostics
  - 📁 Lubrication diagnostics
  - 📁 Service activities
  - 📁 Product Inspection
- 
- 📁 Wideband RMS or PEAK measurements of acceleration, velocity and displacement
  - 📁 Velocity measurement from 10Hz, optionally from 1 Hz for low speed machines
  - 📁 Time signals measurement
  - 📁 Spectrum FFT analysis
  - 📁 Measurement in frequency bands for bearing diagnostics
  - 📁 Headphones for "listening of vibration"
  - 📁 Built-in ISO 10816 limits
  - 📁 Fault Source Identification and Diagnostics Tool
  - 📁 Built-in Infrared Thermometer
  - 📁 Built-in stroboscope lamp
  - 📁 Detection of machine and bearing conditions
  - 📁 Machine speed detection
  - 📁 Colour display
  - 📁 External piezoelectric accelerometer with 100 mV/g sensitivity
  - 📁 Overload indicator, sensor fault and cable fault indicators
  - 📁 Built-in torch
  - 📁 Simple control by three buttons

Ref. No.: 0201\_2012

## **Contents**

<b>Why perform vibration diagnostics.....</b>	<b>4</b>
<b>Why A4900 Vibrio III ? .....</b>	<b>5</b>
<b>Vibration Diagnostics - Basic Information.....</b>	<b>6</b>
Introduction.....	6
Basic Rules.....	6
Machine and bearing condition diagnostics.....	7
Methods for ball bearing condition diagnostics.....	7
The relation between gears and ball bearings.....	7
Fault Source Identification and Diagnostics Tool.....	8
Measurement Points.....	8
The preparation of the measurement point .....	9
Listening to Vibrations Using Earphones.....	10
Relationship of Measuring in Acceleration and Speed .....	10
Abbreviations used in the guide .....	10
<b>What Will You Get with Your Instrument .....</b>	<b>11</b>
Instrument and accessories .....	11
<b>Before You Start .....</b>	<b>12</b>
<b>Standards for vibration measurements .....</b>	<b>13</b>
Adash Limit Values of Machine and Bearing Vibrations .....	14
ISO 10816 limit values .....	15
Classification according to machine type, nominal power or shaft height.....	15
ISO Groups 1-4 classifications define the following types of machinery:.....	15
Classification according to foundation .....	15
Evaluation ranges .....	15
Classification of vibration values for machines groups 1 and 3 .....	16
Classification of vibration values for machines groups 2 and 4 .....	16
Values setting in A4900 Vibrio III unit.....	16
<b>Quick Start .....</b>	<b>17</b>
Preparation of Measurement Point.....	17
Putting in Batteries.....	17
Plugging in Vibration Sensor.....	18
Connectors - top panel.....	19
Vibration Measurements .....	19
Temperature measurement.....	19
Automatic detection of the machine speed.....	20
Evaluation of the machine and bearing conditions .....	20
Fault Source Identification and Diagnostics Tool.....	20
The Stroboscope .....	21
The Torch .....	22
<b>Instrument Operation .....</b>	<b>23</b>
Switching on and off.....	23
Stand by mode.....	23
Information line .....	24
Using of earphones.....	24
Selection of Measurement .....	25
Measurement Methods Screens .....	25
Speed detection and definition .....	28
Menu for functions selection .....	29
LIGHT .....	29
STROBO.....	30

- VOLUME..... 30
- SETUP ..... 31
- SPEED..... 31
- ALARMS ..... 32
- UNITS ..... 32
- ESC- ..... 32
- Error Messages ..... 33
  - Sensor connection Error ..... 33
  - Display Value Overload ..... 33
  - Input Overload Error ..... 33
  - Measurement Error..... 34
- How to evaluate the failure ..... 35**
  - Overall RMS values ..... 35
  - Overall PEAK values..... 36
  - Spectrum 200 Hz– Detection of Looseness ..... 36
  - Time signal for bearing condition evaluation ..... 37
  - Vibrations in frequency bands – gearboxes/bearings. .... 39
  - Fault Source Identification and Diagnostics ..... 40
- Adash 4900 – Vibrio III Specifications ..... 41**
- Response specification ..... 42**
  - Vibration velocity measurement frequency response ..... 42
  - Vibration acceleration measurement frequency response ..... 42
  - Velocity measurement amplitude response..... 42
  - Acceleration measurement amplitude response..... 42
- Calibration recommendations ..... 43**
  - Sensor sensitivity ..... 43
  - Basic test with A4801 Sensor Simulator..... 43
  - Basic test with sensor and shaker ..... 43
  - Advanced tests of velocity measurement ..... 43
  - Advanced tests of acceleration measurement..... 44
  - Envelope demodulation test..... 44

## **Why perform vibration diagnostics**

Vibration diagnostic allows checking the condition of all your machinery. You will be informed early about potential failure before the machine gets damaged and you will be able to order only real specific required maintenance (instead of expensive overhauls). The periodical measurements will allow you to keep your machines in good health.

## **Why A4900 Vibrio III ?**

You always ask before you make a decision to buy the new instruments what unit is the best for your needs. Is it an instrument with a large amount of functions, including specialized software for data processing (which you will not ever use), or is it an instrument which is easier to use and contains all required functions? You should pay only for functions, which you will use in the field. The A4900 is just that instrument. The instrument uses standard external accelerometer with the magnetic base. It enables correct repeatable measurements. You should not equate our unit with "vibration pens".

The Adash model A4900 is a multi-function portable meter that bridges the gap between the basic and advanced FFT data collector/ analyser. It is a complete machine condition expert system than gives results without the use of a computer or lap top. It is designed for the technician, engineer and consultant who need to analyse a rotating machine on-site without investing and carrying expensive instruments to site.

This single meter undertakes overall vibration measurement, three band spectrum, 200lines spectrum, Time Wave Form, temperature, tacho for speed, strobe scope. In addition it incorporates a handy inspection torch.

The A4900 caters to ISO 10816-3 with expert rules covering machine health vibration levels: that identify the prime machinery faults: Unbalance, Looseness and Alignment. An anti-friction bearing health level indication is also incorporated. Many informative screens are available.

Do your machines work under optimum conditions? The A4900 will:

- Determines the condition of your bearings, including slow-running ones.
- Identify insufficiently lubricated bearings.
- Indicates unbalance, looseness, misalignment.
- Check unbalance, alignment and loose foot
- Check machine speed by built-in stroboscope.
- Check machine temperature by Non contact temperature meter.
- Measures in either Metric or English units.

Operation of A4900 is easy to use. Colours green, orange and red display the status. Determination of individual machine or bearings defect types is done directly during operation, without need of use a computer or software. Despite the A4900 is very compact and rugged, it is designed and fits in the palm of a small hand. Nevertheless the A4900 is big in performance.

The A4900 is supplied complete set with an accelerometer, coiled cable, magnetic base, transit case and earphones. You can connect earphones to listen to machinery noise related to vibration and process. When measuring transmissions or slow-running bearings, you will quickly appreciate the benefits of the earphone accessory.

# **Vibration Diagnostics - Basic Information**

## **Introduction**

What is it the vibration diagnostics? This chapter explains the basic steps and you will be able to begin practical measurements. More information you can find in the literature.

**When we are talking about the vibration diagnostics, we mean regular measurements (usually every 2-4 weeks), whose objectives primarily are:**

- 1. Finding of change of vibration level, it means change of machine operational condition.**
- 2. Determining reason of this change.**
- 3. Recommending maintenance (repair, adjustment, lubrication etc.).**
- 4. Checking of maintenance success (including revision of dismantled part to confirm the analysis).**

**The machine vibration diagnostics solves two basic tasks:**

- 1. Diagnostics of machine mechanical failure (imbalance, misalignment, mechanical looseness etc.).**
- 2. Diagnostics of rolling bearing condition.**

## **Basic Rules**

**1. If the measured value of vibration increases in time, it is a change indicator - worsening of the machine condition.**

**2. If the measured values do not change, the machine works in stable operation condition.**

This doesn't necessarily mean good condition. For example if a bearing was installed incorrectly, then there will be high signal value immediately. This value will remain stable for some time (the bearing will be able to withstand it), but then there will be a fast increase and destruction of the bearing. This short bearing life can take hours, days, weeks or even months.

**3. Reliability of the diagnostics will never be 100%.**

There will always be defects, which develop in time shorter than regular measurements. The defects caused by material fatigue can develop in several seconds only (cracks, breaks). The proof of the diagnostic performance is primarily a decrease in maintenance costs (not to absolute zero) and a significant decrease in unexpected breakdowns (not their complete elimination).

**4. Using of standards is possible only with special machines, for which the special standards exist.**

It is not possible to simply define limit vibration values in general for a wide range of machines. However, it is possible to create the standards for special machines (e.g. turbines), and these standards are a strong diagnostic tool. General standards have a character of recommendation on how to define the limit values. The way how to find the good condition values is to use measured values of new or repaired machine. Also you can ask the machine producer for them.

**5. Shortening of an interval between measurements means more successful prevention of unexpected failures.**

## **Machine and bearing condition diagnostics**

Basic defects which we'd like to find out are

- unbalance (heavy spot on the rotor causes vibrations),
- misalignment (machinery parts are not in alignment ),
- looseness (machine is not properly connected with its base - soft foot),
- bearing defect (wear of bearing, bad assembly, bad lubrication or overload).

First three defects influence the whole machine (e.g. the vibration caused by unbalance we can take from any point on the machine). We use the vibration velocity [mm/s] measurements for that.

Roller (ball) bearing condition we can detect only on the nearest point. This is the local failure. We measure always vibration acceleration only [g].

## **Methods for ball bearing condition diagnostics**

We can find out several methods for bearing condition detection in literature. We should repeat again:

### **We have to measure vibration acceleration in [g]**

for correct data acquisition. All methods must satisfy the conditions.

We can choose different procedures for evaluation of the acceleration signal. Measured signal can be imagined as a level of the river. It flows with appropriate speed and there are little or big waves. If we want to measure the stream we can measure the flow per hour or prompt wave's level. The value of the flow will be stable and it will change slowly. But the wave's levels are unstable because measurements have significant variety of values.

The similar effects occur for bearing condition measurements. You can measure RMS value (the total energy in signal) or PEAK value (the highest peak in signal). We can use both types for evaluation, just have to realize of advantages and disadvantages.

#### **RMS measurement**

- **advantages**                    - stable and well repeatable, time trends are well readable
- **disadvantages**               - if wear increases the response is slower then PEAK, but sufficient for maintenance.

#### **PEAK measurement**

- **advantages**                    - fast response for any condition change.
- **disadvantages**               - not stable and well repeatable (extremely sensitive), time trends are not well readable.

From these two basic measurements further measurements are derived:

- **g<sub>ENV</sub>**                               - envelope signal modulation. Advantages and disadvantages are in the middle of RMS and PEAK measurements.
- **g<sub>SE</sub> BCU, SEE, SPM** - measurements are performed usually on the sensor resonance frequency. These methods have the same advantages and disadvantages like the PEAK measurement.

## **The relation between gears and ball bearings**

For gearboxes diagnose it is also necessary to measure acceleration signal like for ball bearings. When the balls are rolling over the damage tracks (pitting), the shock pulses occur in signal. Unfortunately similar shocks are also in signal from on worn or damaged gears. So if we measure gearbox with roller bearings then higher vibration values can be caused by both sources. More information for this kind of analysis you can find in chapter Vibrations in frequency range - gearboxes/bearings.

## Fault Source Identification and Diagnostics Tool

This tool is included in the Adash 4900 Vibrio III. It is good message for users, because such function has never been built in the instrument in this price category. This function display several bar graphs with traffic light colours. Two major (largest) bars are allocated to general machine condition ( on the left side) and ball bearing condition (on the right side).

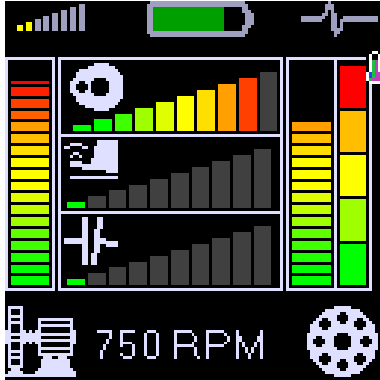

The next three bars are located in the middle. They display the severity level of UNBALANCE, LOOSENES and MISALIGNMENT (from the top).

## Measurement Points

The measurement location must enable repeatable measurements under the same conditions as the previous measurement. Also the direction of sensor ( radial, axial for rotated machines) is important.

That is why you should determine measurement points on the machine. The typical machine together with the measurement points on the picture.

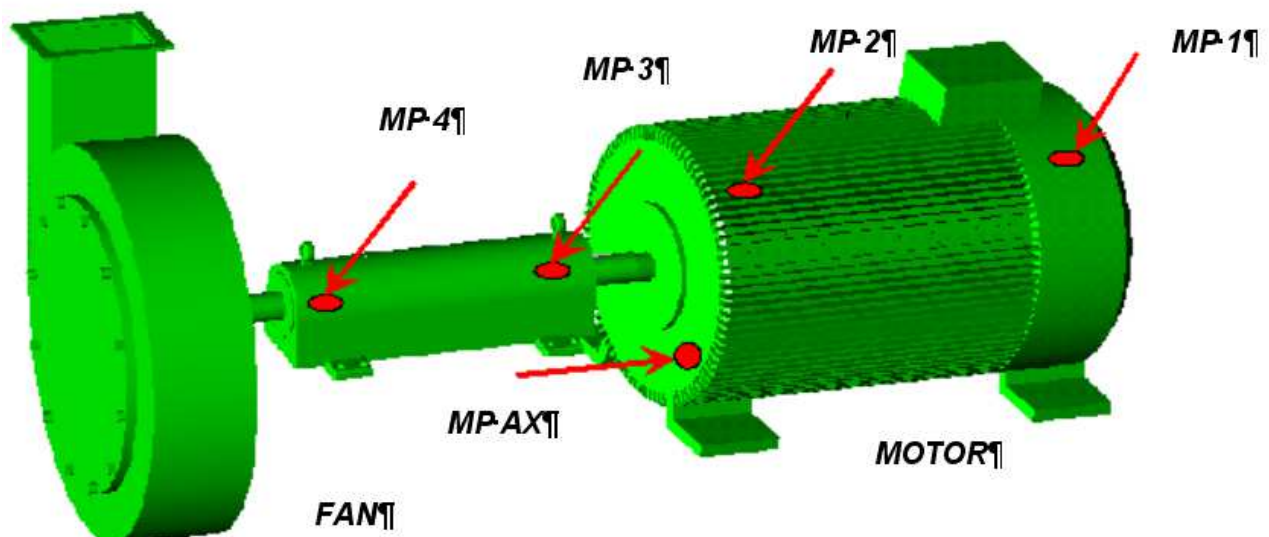

For the measurement in radial direction, we are going to place the sensor perpendicularly to the axis of rotation, for axial measurement along the axis. The radial measurement can be usually performed horizontally, vertically or in another angle. The importance of the angle choice should not be overstressed; choose any radial direction with easy access.

The measurement points need to be prepared for the measurements. The best is to place measuring pads on a machine (see the chapter Preparation of Measuring Location).

### ***The preparation of the measurement point***

On the measurement point we make a measurement. To obtain a quality measurement, the points for measurements must be prepared in advance. For regular measurements the sensor must be always fixed in the same way at the same point. For diagnostics of bearings it is necessary to fix the sensor with a magnetic base. Do not push the sensor only by hand - high frequencies cannot be measured in this way.

The magnetic base is firmly screwed to the sensor and then it is magnetically fixed to the metal surface of the machine. Hence the sensor is fixed and a measurement is possible. Quality of fixation markedly influences the result of your measurement. If the sensor swings or jumps about etc., your measurement is pointless. A layer of paint is also a big obstacle for higher frequencies. The magnetic base has ground surface and the same surface quality must be created on the machine. In practice, it is not possible. A flat surface 3x3 cm in size can be ground only in a workshop. Anyway, quality of the bearing's housing steel is not high and such a surface can quickly succumb to corrosion. Then it becomes unusable.

Solution to this problem is to use measurement pads. These are the cylinders with the diameter approx. 26 mm and height 10 mm with a ground surface, made of a magnetic stainless steel. They are fixed to chosen points with special glue, which ensures a perfect transmission of the high frequency vibrations. The pad is covered with a plastic cover, which is removed only for the measurement. Another advantage of the cover is that when the machine is painted, your measurement point is preserved. The paint would devalue the pad. It is sufficient to coarsely grind the machine's surface and degrease it before the pad is glued. Durability of the pads in time is unlimited. In practice, it is always until a forcible removal.



You will need mainly the following aids: angle grinder, set of files, sand paper, degreaser (ethanol, solvent), measurement pads and glue.

Prepare the surface in the following way:

- remove the paint, corrosion or unevenness from the surface by grinding,
- degrease the surface.

The pad is being fixed on measurement point with the glue. We usually use the METAL TECH SG cement, also other glues with similar properties may be used.



The METAL TECH SG cement is a 2-component epoxy cement with properties best suited for this task. The two components, after mechanical mixing, chemically react and after drying they form a hard material resistant to pressure, temperature and humidity.

In the case of the simple pad the procedure is as follows: cut-off a disc approx. 3 mm thick from the cement with a sharp knife. Wet your fingers and work the disc into a homogenous lump. Roll a cylinder with the diameter approx. 2-3 mm from this lump and put it on the side, which is not roughened.



Further technical and

can be found at [www.adash.eu](http://www.adash.eu)

Push the pad with glue to the prepared place and, while constantly pushing and turning the pad there and back with circular movements, observe that the cement is being evenly pushed out along the circumference of the pad. The purpose is to make the layer between the pad and the surface as thin as possible.

**! ATTENTION. CEMENT MUST NOT BE PUSHED OUT COMPLETELY!**

Pushed out cement may be removed or levelled out around the pad. In the end you put a cover on the pad.

When using the **T** pad, amount of the cement is dependent on the size of the gap between the motor ribs and it is not so easy to determine amount of the cement to process. As with the simple pad, the surface between the ribs must be well cleaned and degreased. The space shall be filled with the necessary amount of the cement so that only the cylindrical part of the pad remains visible after drying of the cement. In the end put the cover on the pad.

### ***Listening to Vibrations Using Earphones***

A user can connect earphones to the Adash 4900 – Vibrio III instrument, since listening to a measurement signal also enables a differentiation of a problem type. People can think that this is an old method, which does not have a place in this modern world. The opposite is true. Analysis of gears and low speed bearings (e.g. in paper mills) gain better quality by using the listening method. The listening can easily be done by any maintenance person without deeper knowledge of diagnostics. If there is a defective bearing, distinct rumbling sound is audible in the earphones then. If the bearing is OK, then you can hear only a weak noise.

#### **EARPHONES WARNING !**

**Listen at moderate volumes to avoid hearing damage.**

**Always remove the earphones from the ears when you move the sensor or re-connect cable.**

### ***Relationship of Measuring in Acceleration and Speed***

Maintenance staff usually measure vibrations in mm/s or inch/s (velocity) only and not vibrations in  $g = 9.81 \text{ m/s}^2$  (acceleration). This is a relic of the past, when old equipment enabled the vibration speed measurement only. Bearing defects are not recognizable by using velocity measurements. If the velocity value increases due to a bearing defect, then the defect is already serious and there is an acute danger of unexpected breakdown. The measuring of the velocity vibration does not give early enough warning before failure of a rolling bearing.

For accurate bearing condition measurement you have to measure the acceleration vibration!

### ***Abbreviations used in the guide***

Abbreviations below are used in the User's guide

RPM – Revolutions per minute  
CPS – Revolutions per second  
RMS – RMS value of the measured signal  
PEAK – Peak value of the measured signal

## **What Will You Get with Your Instrument**

### Instrument and accessories

The instrument case contains:

- measuring instrument A4900 – Vibrio III
- vibration sensor - accelerometer
- magnetic base for vibration sensor
- coiled cable to connect vibration sensor
- earphones
- measuring tip for putting manual pressure on vibration sensor
- 1.5V alkaline batteries
- CD with the manual



Fig. Adash 4900 – Vibrio III with accessories

## **Before You Start**

Ignoring any of the recommendations mentioned below may cause failure of the instrument.  
Handling voltage higher than 24 V can cause an accident.

1. Always connect only ICP type sensors into an ICP marked socket !  
If unsure, consult the procedure with your supplier.
2. Never plug this instrument into 230 V household voltage !
3. To power this instrument, use batteries with max. nominal voltage of 1.5 V!
4. To power this instrument, use only alkaline or rechargeable (NiCd, NiMH) batteries.  
Regular carbon-zinc batteries are not suitable.

**WARNING!**  
**Use correct battery polarity.**  
Incorrect polarity will cause destruction of the instrument!

**EARPHONES WARNING!**  
Listen at moderate volumes to avoid hearing damage.  
Remove the earphones from the ears when you move the sensor or re-connect cable.

## **Standards for vibration measurements**

Using a standards is occasional topic in vibration diagnostics. Because there are a lot of different types of machines it is impossible to determine the critical limits of vibrations for wide range of machines. Its reliability would be low then. It would happen, you will repair machine, which do not require it. The standards should be rather determined for a narrow range of machines.

A4900 Vibrio III contains **Adash** limit values and ISO 10816 limit values. Adash limits are not rewritten from any existing standard. It's a result of 20 years of **Adash** engineering team experiences. It's difficult to invent critical value definition which would be simple (that means not many parameters such as speed, power, bearing type, machine type and so on) and reliable.

On the figures below is clear how we derived limit values. Three levels of machine condition are defined: GOOD, ALERT (Machines lays in this range are not acceptable for a long period operation, they could be operated till time when could be repaired) and DANGER (Vibration values in this range are considered as very dangerous an they can cause a damage of the machine). The corresponding colours are taken from traffic lights - green, amber and red.

All limit values are related to the speed value. The low speed machine should generate lower vibration then higher speed machine.

In the graphs area you found three particular areas. GOOD condition is the space up to the yellow line that means operation without restriction. The space above yellow but under red line is an ALERT condition. Possible to operate the machine but have to be more checked. It's necessary to determine the source of worse condition and plan repair (for instance change the bearing) or maintenance (balancing, alignment). The space above red line is an DANGER condition and the machine should not be operated. First figure contains the values for overall machine condition and you search unbalance, misalignment, and mechanical looseness above all. They are called "overall" because we can measure them on most of the measuring points. Second figure contains the limit values of a roller bearing condition. This condition is local and can be measured only on appropriate bearing house.

Work with figures is simple. It's necessary to know the speed. Instrument determines it automatically or user can enter it manually. On the bottom horizontal axis you should find the point which corresponds with speed. Above this point you will find an intersection with orange and red graph. Projections to the vertical axis will determine limit values for amber or red state. If the measured value is lower than amber the condition is GOOD – green. If the value is above amber but under red then the condition is ALERT – amber. If the value is higher then red graph then the condition is DANGER – red.

### Adash Limit Values of Machine and Bearing Vibrations

Graphs, according to which the instrument determines acceptable vibration limits depending on machine speed.

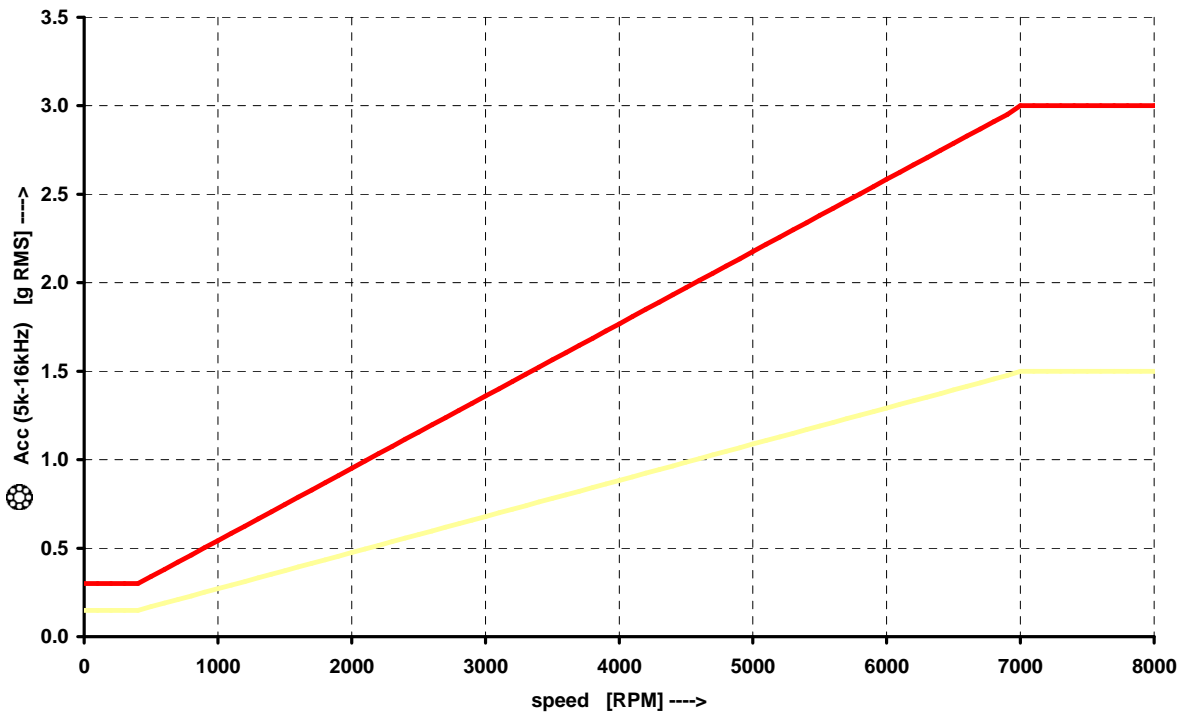
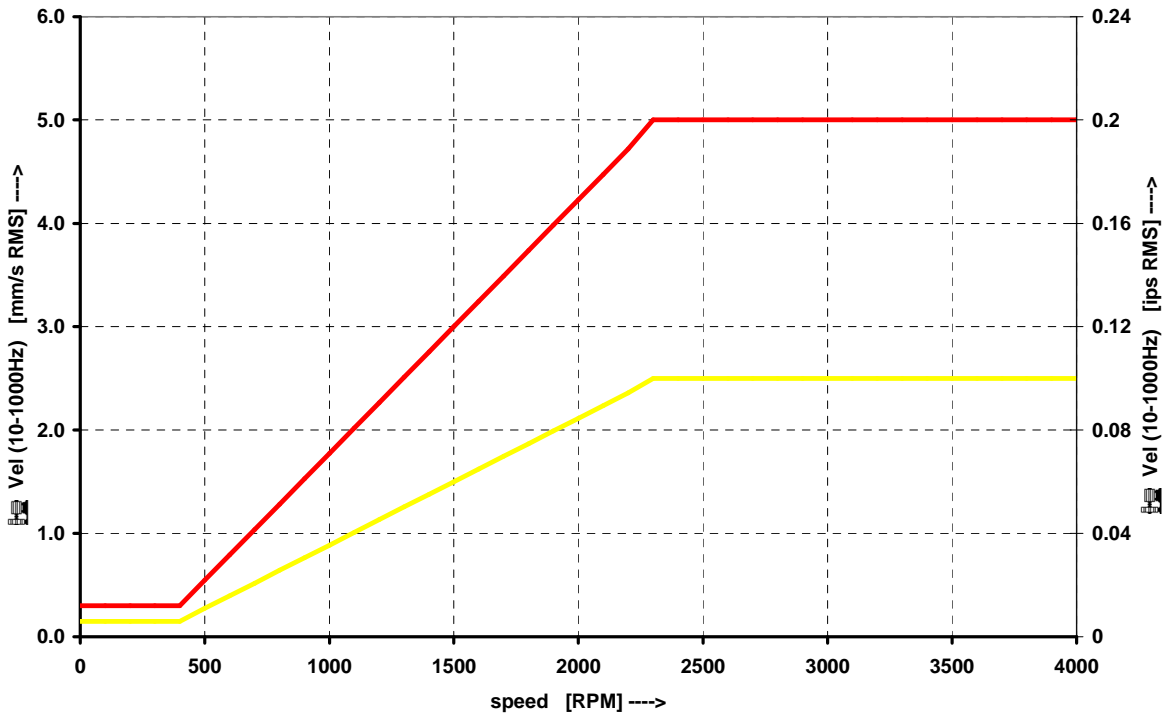

## **ISO 10816 limit values**

There is a wide range of valid standards but we would like to mention ISO 10816. It has several sections and it also deals with procedures how to gain limit values for particular machines. It contains 3 tables of values, which are applicable for A4900 Vibrio III unit.

### ***Classification according to machine type, nominal power or shaft height***

Therefore, select the Group that best describes the general size, type, and speed of the machinery being measured. Note that these machine group classifications are set forth in ISO 10816-3, which rates overall velocity vibration levels for industrial machines with normal power above 15kW and nominal speeds between 120 r/min and 15000 r/min when measured in situ.

### ***ISO Groups 1-4 classifications define the following types of machinery:***

#### **Group 1**

Large machines ( rated power above 300kW) with a shaft height greater than 315 mm. These machines are normally equipped with sleeve bearings.

#### **Group 2**

Medium-sized machines (rated power from 15 kW to 300 kW) and electrical machines with a shaft height between 160 and 315 mm.  
These machines are normally equipped with rolling element bearings.

#### **Group 3**

Pumps with multivane impeller and with separate driver with rated power above 15 kW.

#### **Group 4**

Pumps with multivane impeller and with integrated driver with rated power above 15 kW.

### ***Classification according to foundation***

An additional setting allows the specification (when defining the overall alarm levels) of measurements taken from machinery with Rigid or Flexible foundations.

### ***Evaluation ranges***

For evaluation of the machine health from vibrations there are defined following evaluation ranges.

**Range A:** New machine vibrations should occasionally be in this range.

**Range B:** Machines in this range can be operated for unlimited period.

**Range C:** Machines in this range are not acceptable for a long period operation, they could be operated till the repair time only.

**Range D:** Vibration values in this range are considered as very dangerous as they can cause a damage of the machine.

**Classification of vibration values for machines groups 1 and 3**

Foundation class	RMS velocity values		border zone
	mm/s	in/s	
Rigid (R13)	2,3	0,09	A/B
	4,5	0,18	B/C
	7,1	0,28	C/D
Flexible (F13)	3,5	0,14	A/B
	7,1	0,28	B/C
	11,0	0,43	C/D

**Classification of vibration values for machines groups 2 and 4**

Foundation class	RMS velocity values		border zone
	mm/s	in/s	
Rigid (R24)	1,4	0,06	A/B
	2,8	0,11	B/C
	4,5	0,18	C/D
Flexible (F24)	2,3	0,09	A/B
	4,5	0,18	B/C
	7,1	0,28	C/D

**Values setting in A4900 Vibrio III unit**

It's possible to set up these values directly in the unit. Then the measured values are displayed in traffic light colours. You can choose Adash limits (recommended) or 10-816 limits. Setting up is in menu under the mode SETUP (see instrument operation).

Coloured marks according to 10-816 are ranges A and B, displayed by green colour. Range C is amber and range D is red. It's necessary to choose a type of evaluation R13, F13, R24 or F24 (see table above).

## **Quick Start**

The aim of this chapter is to introduce you this instrument, and, without reading a complete User's Guide, enable you to measure first vibration values. This chapter does not describe full and detailed operation of this instrument or measurement methodology. Special chapters in this Guide are intended for this purpose.

### ***Preparation of Measurement Point***

We have to select a measurement point before the measurement itself. We want to choose it in such way that transmission of vibrations would not be attenuated. Usually this means as close to the source of vibrations as possible (for instance at a bearing housing). We always have to measure at solid, firm part of a machine. We should not be measuring on covers and so on. The place should be clean, without corrosion and paint. It should also be flat so a sensor would not "wobble". The best is to use a measurement base, which is glued on a machine. It has a perfect surface, plastic cover, and is made from magnetic stainless steel. This will enable you to perform the measurements on the machine at any time under the same conditions. Measurement repeatability means that you will be able to compare values well.

### ***Putting in Batteries***

Batteries are accessible after opening a lid at a bottom part of the instrument. Open the lid by pressing its lower edge (the edge with hinge), the lid upper part opens easily - see figure. Do not ever use force! Proper polarity is shown on the picture.

***Do not forget to switch the instrument off before opening the power battery lid!  
Never handle the power batteries with the instrument switched on!***

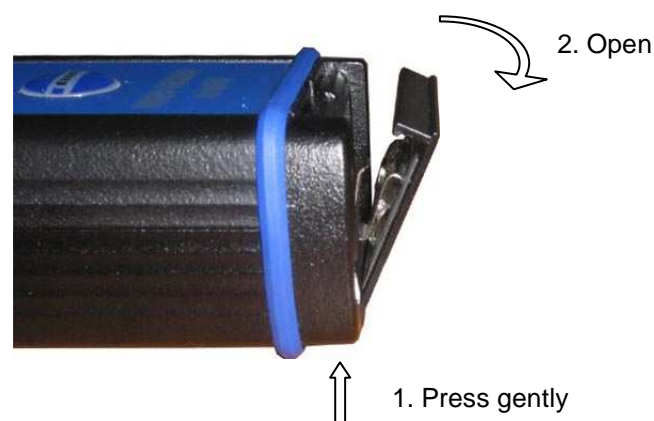

Fig. Opening of the lid



Fig. Placement of power batteries

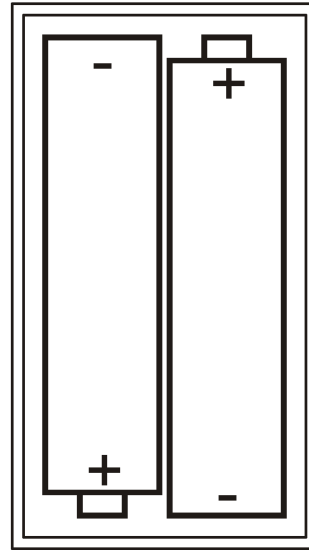

Fig. Proper cell polarity

### ***Plugging in Vibration Sensor***

To measure a vibration signal we need to plug in the vibration sensor with **ICP** power. The plugged in sensor must be a standard **accelerometer with 100 mV/g sensitivity**. The instrument is equipped by its own source of ICP power for connected sensor. The sensor needs to be connected at the right input plug by a supplied cable.



Fig. The instrument with a sensor connected

## Connectors - top panel



The earphones output is on the left ( 3.5mm jack). The accelerometer input is on the right side. The contact-less temperature sensor is on the bottom. Four LEDs of strobo are in the top of panel.

## Vibration Measurements

Screw the sensor onto the magnetic base. Do not forget to remove the plastic cover and a metal washer (it closes a magnetic field for longer service life of the magnet) before measuring. Place the plastic cover and the metal washer back on the magnet after measuring.

Place the magnet on a measuring point very carefully. Best is to rest the edge of the magnet on its side and then slowly lower the sensor onto a machine. If you bring the magnet near to the machine with its whole area hitting the machine all of the sudden, then the strong impact can irreversibly destroy the sensor.

In case you use a measuring tip instead of the magnet, measured values are not going to be stable. This is not surprising. The measured values depend to a large extent on a pressure of the tip at the measurement point. The magnet that attaches the sensor generates a constant pressure so the values are stable.

**Attention!!!** Use the measuring tip only in hard to reach places, where it is not possible to place the magnetic base.

## Temperature measurement

Infrared sensor for temperature measurement is aside from accelerometer input. Measurement angle is about 45 degrees around the sensor centre axis. Best results are taken with sensor distance 10-20 cm from measured surface. The accuracy of result depends of emissivity, this is typical property of IR temperature sensors.

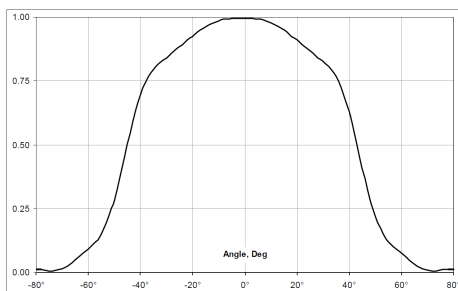

Sensor sensitivity vs. the angle

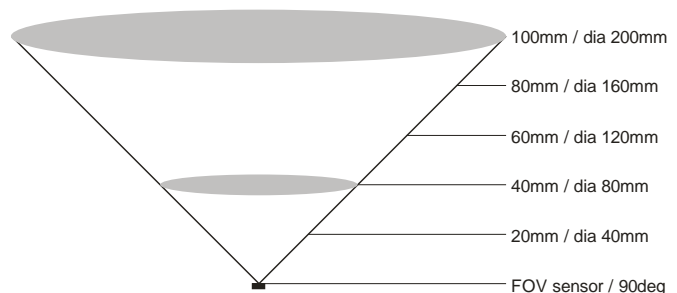

The size of the scanned area vs. distance

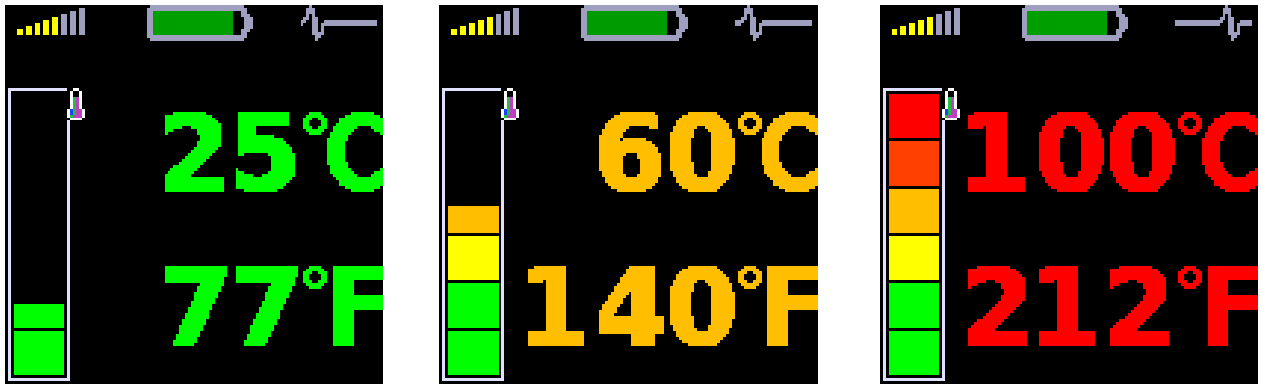

Measured temperature is displayed in Celsius and Fahrenheit degrees. Also the coloured bar is used. The bearing symbol on the other displays is also coloured according to the actual temperature value. The ranges of colours are for less than 30°C - green, 30-45°C - yellow, 45-60°C - orange, 60-75°C - red and for greater than 75°C – dark red.

### ***Automatic detection of the machine speed***

It's important to know the speed for evaluation of the machine condition. Instrument is looking for speed in the frequency spectrum (200Hz range). It is assumed that most of the vibration energy is located on the speed frequency. If the instrument finds significant energy level on one frequency (that means in very narrow band) then this frequency is labelled as the speed frequency. From this description is clear that the speed has not to be found always. If the higher level of energy is located in the spectrum on other line then speed frequency (for example frequency of the fan blades), then the wrong result can be displayed. However the correct speed, which must be defined for condition levels, can be entered manually as well..

### ***Evaluation of the machine and bearing conditions***

Diagnostician is always asking a basic question after measurement: "What condition of the machine should I assign to this measured value?"

Machine conditions are divided into 3 levels, which have the same colours like traffic lights:

1. GOOD – GREEN COLOR

Machine is in good condition, no defect is found. The operation is without restrictions.

2. ALERT - AMBER COLOR

The beginning defect has been found on the machine. It is possible to operate with paying more attention and planning of repair.

3. DANGER – RED COLOR

Serious defect has been found on the machine. Machine shouldn't be in operation.

Special functions are included in the instrument for detection of that three states. The overall vibration values are coloured with appropriate colour.

The vibration limits **Adash** for each state are determined from the graphs, which are printed in the **Adash Limit Values of Machine and Bearing Vibrations** chapter.

### ***Fault Source Identification and Diagnostics Tool***

Press the left arrow on the screen No.1 and the Fault Source Identification and Diagnostics screen appears. For correct evaluation the speed must be defined. The instrument can do it automatically or by user manual entry.

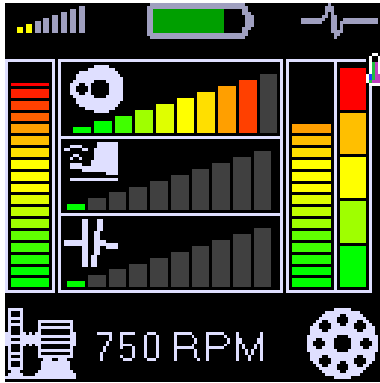

In the left bottom corner you see the Machine icon. The vertical bar displays the general (overall) machine condition. This condition can be evocated by many reasons. The unit evaluates the severity of 3 sources, which are the most occurred in the practice:

- Unbalance ( circle with heavy spot icon),
- Looseness ( shoe icon),
- Misalignment ( clutch icon).

Correspondent faults horizontal bars are in middle.

On the right bottom corner you find the rolling bearing icon. The vertical bar displays the bearing condition.

## The Stroboscope

The build-in stroboscope inside the A4900 Vibrio III represents the unique innovation in the handheld vibration analyzer field. We use the high lighting LED technology, which low power consumption enables to use the stroboscope in our instrument.

**Stroboscope** or stroboscopic lamp, commonly called a strobe, is the device which produces regular flashes of light. When we have to study or to visually inspect the machinery, which have cyclically moving parts, then the stroboscope enables to froze the moving ( usually rotation). Imagine the simplest form, a rotating disc with one-spaced hole. When the flashes of light are synchronized with the rotational speed of the disc, then just one flash is made during one rotation. It means, the disc is lightened up when the hole is always in the same position. It is the principle of illusion of frozen movement. See the Menu chapter for details.



## **The Torch**

You sometimes need to inspect or read the dark corners. In that time you are lucky with A4900 - Vibrio III, because this instrument has built-in torch in front panel. See the Menu chapter for details.

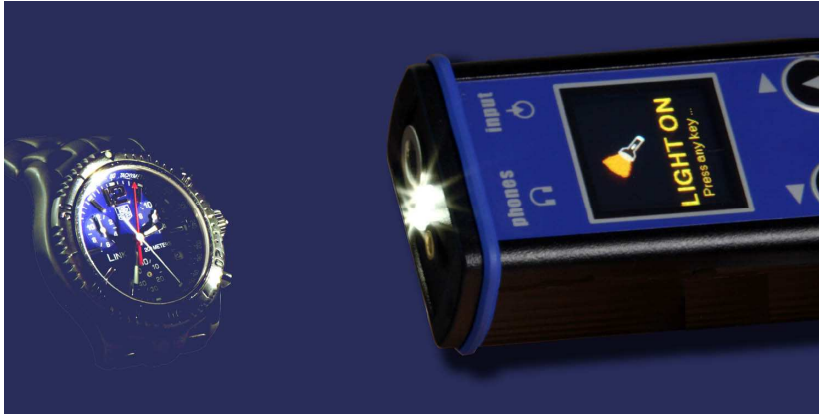

## Instrument Operation

### Switching on and off

The instrument is switched on by pressing of the middle button .

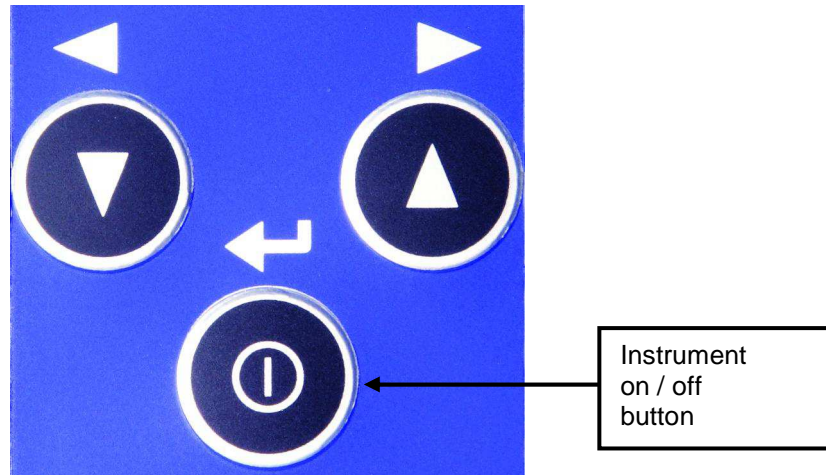

Fig. Buttons / Switching the instrument on

Provided that batteries with sufficient voltage are placed in the instrument then a display will show an instrument Logo. If the batteries are weak the VIBRIO sign is bordered in red.



Fig. Switching on



Fig. Switching on with weak batteries



Fig. Switching off

#### Description of numbers in initial screen:

1. The sensor sensitivity mV/g times 10 ( 983 means 98,3mV/g)
2. Firmware version ( V2.05dtH)
3. HP filter frequency for bearing in kHz ( 0,5 kHz)

The instrument is **switched off** by pressing and holding the same button  for a longer time. The POWER OFF appears on the display. Release the button and the instrument switches off.

### Stand by mode

When the user does not press any button for 10 minutes, the instrument changes the standard run mode to the Stand by mode - the screen is darkened. When the user does not operate with the instrument next 30 minutes, the instrument switches off.

## Information line

After powering on the display shows measured data. Beyond descriptions of the measured values and their actual values the display shows an information line in its upper part.



Fig. Information line on a display

### Meaning of Displayed Symbols:



- moving “wave” signifies measurement in progress,



- setting of earphone output volume is indicated by yellow coloring of the bars,



- this symbol shows an approximate battery status. If the battery symbol is filled more, then more battery power remains. If the status goes under 20 %, the remaining energy shows in red, if it is insufficient, the symbol is red and the instrument switches itself off.

### Battery status symbol:



100%



approx. 50%



under 20%



just before switching off

## Using of earphones

The instrument is equipped by a 0.5 W amplifier for connecting of earphones and listening to a measured signal. We can connect the earphones by a stereo 3.5 mm jack marked phones on the top of the instrument (see figure in the Connectors chapter). After connecting we can hear a signal from the vibration sensor in the earphones. Advisable volume can be set-up by the VOLUME item from the instrument menu (see MENU chapter)

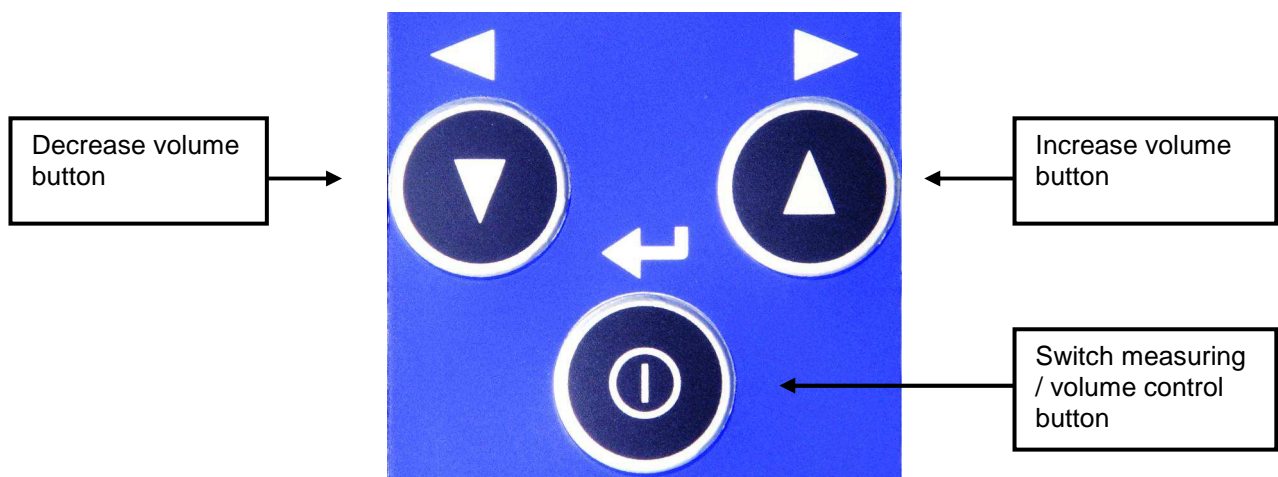

## Selection of Measurement

A selection of measuring screen (method) can be performed by arrow buttons ▼ ▲. After press of a button an “empty screen” is shown without measured data, and the measuring starts.

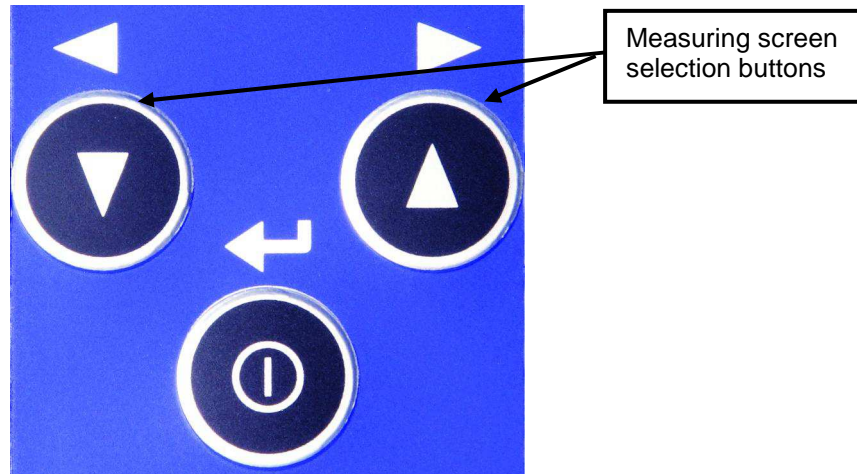
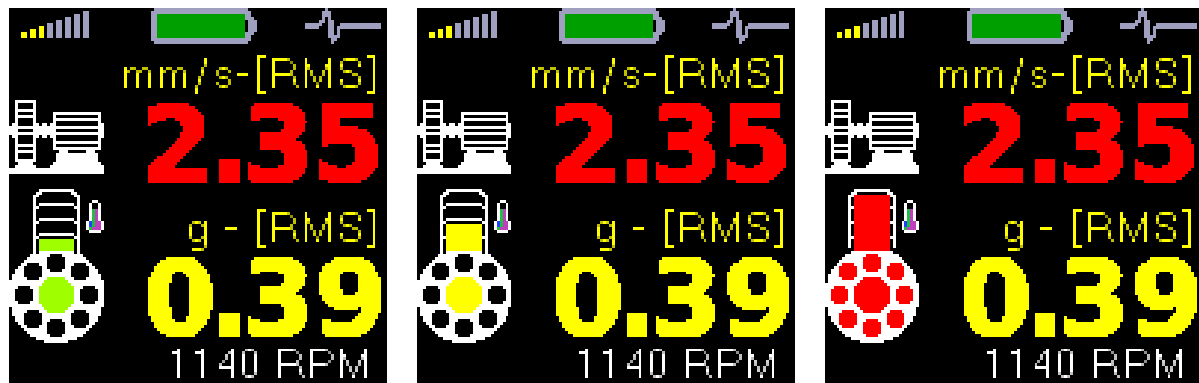

Fig. Measuring screen selection buttons

## Measurement Methods Screens



### Overall RMS values

Measurement of RMS vibration values in the ranges:

10 Hz - 1000 Hz in mm/s,

0.5 kHz - 16 kHz in g,

with estimated value of machine speed frequency.

Based on the speed and vibration values of the machine condition, colour of displayed value - green / amber / red - is determined.

The colour of bearing is determined regarding to the measured temperature.

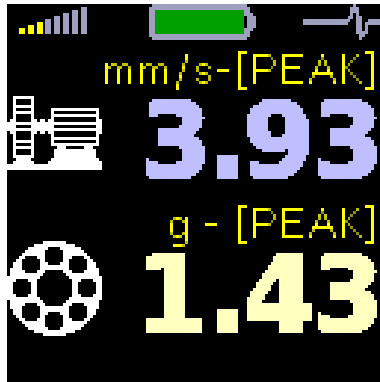

#### Overall PEAK values

Measurement of peak vibration values in the ranges:  
 10 Hz - 1000 Hz in mm/s,  
 0.5 kHz - 16 kHz in g,

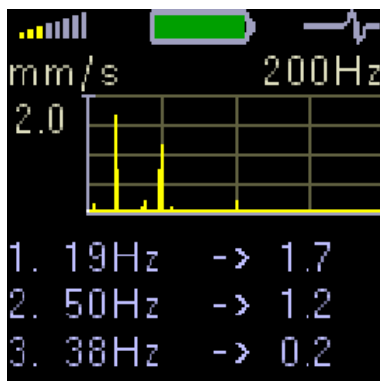

#### Spectrum 200 Hz–looseness detection

FFT analysis of vibrations in the range:  
 2 Hz - 200 Hz in mm/s RMS,  
 with display of 3 maximum peaks found .  
 The peaks are ranked according to amplitude vibration size.

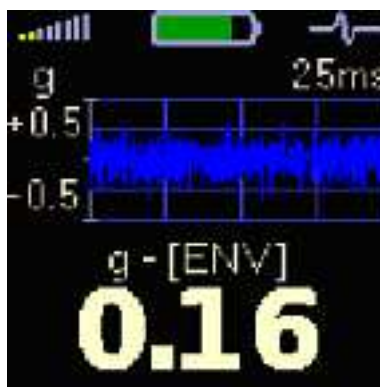

#### Time signal for roller bearing diagnosis

Measuring of time signal and vibrations in the range:  
 0.5 kHz - 16 kHz in g.  
 Displays actual measured time signal and  $g_{ENV}$  value.

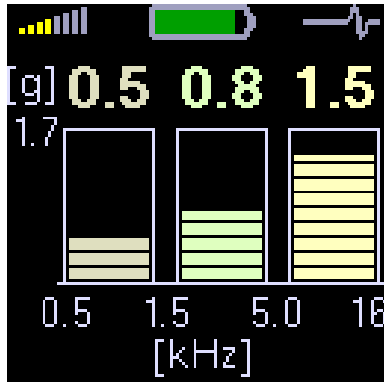

**Vibrations in frequency ranges – gearbox/bearing**

Measurement of RMS vibration values in the ranges:

0.5 kHz – 1.5 kHz in g,

1.5 kHz - 5 kHz in g,

5 kHz - 16 kHz in g.

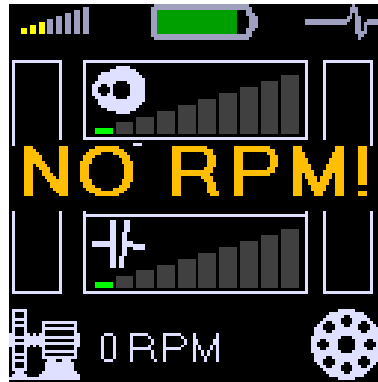
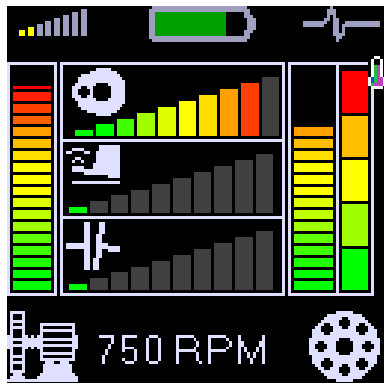

**Fasit expert system**

The FASIT screen. It displays the severity levels of machine faults. Also the temperature bar is displayed on the right side.

When the RPM is not found then no results are displayed (from ver.2.05).

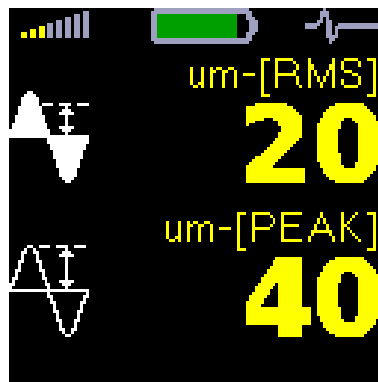
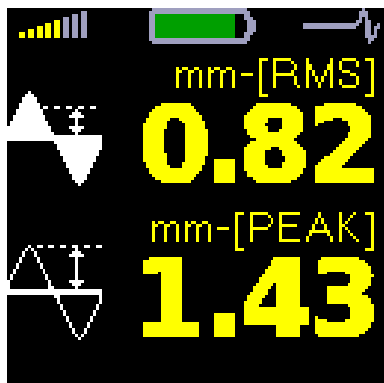

**Overall RMS and Peak displacement** values in the range 2-200 Hz in mm.

From ver.2.05 is the displacement displayed in um.

### Speed detection and definition

After switch on of the instrument the Screen No.1 appears and the automatic speed detection begins. It must be said - obviously. The detection procedure is displayed as running bar in the bottom of screen. The result is also displayed on the bottom.

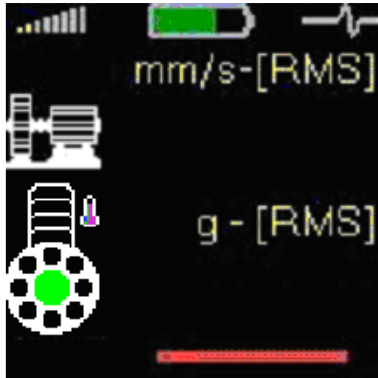

When the automatic speed detection is not successful (see Automatic detection of the machine rotation chapter), the last speed value is loaded from the memory and displayed together with the message **<set>**.

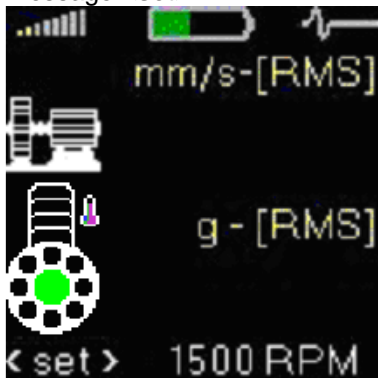

Push arrows, it changes the value of speed with the step 250 RPM. When the correct speed ( or the value near the correct speed) is defined, push Enter button for confirmation.

If no pushbutton is used for approx. 4 seconds, then the displayed value is accepted.

The word **<set>** is changed to **!MAN!** then. This word informs all the time the user, that speed is entered manually.

When you need to set exact value and the 250 RPM step is too much, then use the STROBO item from the MENU.

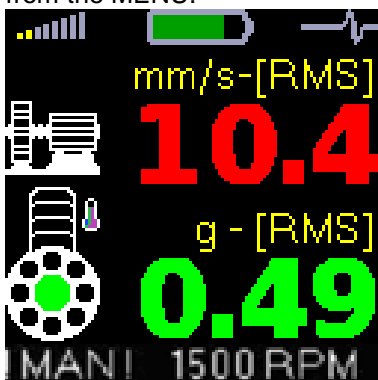

RPM set manually

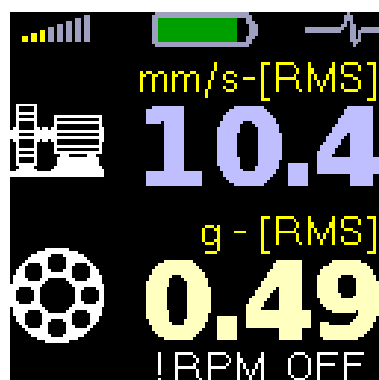

RPM detection switched off

If the automatic detection is switch on, this procedure of speed detection runs always when the Screen No.1 appears. !RPM OFF! is displayed when the RPM detection is switched off.

## Menu for functions selection

By pressing **Ⓜ** button, the instrument menu appears. If the instrument is in the error stage (for example "SENSOR ERROR"), then some functions are not available.

- LIGHT** - Torch mode
- STROBO** - Stroboscope mode
- VOLUME** - Phone output volume adjustment
- SETUP** - This item opens next item selection:
  - SPEED** - Set of speed detection
  - ALARMS** - Selection of standard, which will define limit values
  - UNIT** - Unit options for a measuring of a velocity signal (mm/s vs. ips)
- **ESC** - - Return to the measuring screen

If the error is detected (e.g. "SENSOR ERROR"), then some item are not available. Move between items by pressing **▼ ▲** buttons. Select item by pressing **Ⓜ** button. Use - **ESC** for return from Menu.



Fig.: Instrument MENU.



Fig.: Instrument MENU in error stage.

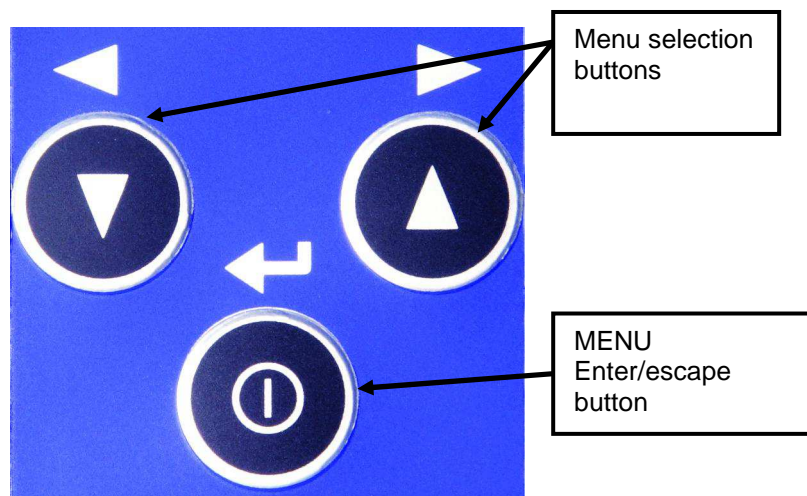

Fig. Meaning of the buttons

## LIGHT

In LIGHT mode it's possible to use instrument like a torch. Select the LIGHT mode and press **Ⓜ** button. White LEDs on the front side begins to light. Symbol of a torch appears on display. Press any button to switch off the light and the instrument starts to measure again.

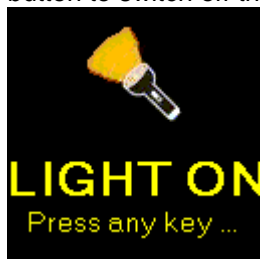

Fig.: Torch mode

## STROBO

In STROBO mode you can use the instrument as a stroboscope. White LEDs on the front side begins to flash with a frequency, which is set up on the screen. If the speed detection is known, then frequency of flashes is set to that value. By pressing ▼ ▲ buttons you can also change that frequency manually. The step (1,10,100 RPM) is displayed on the bottom line of the screen. Press the Ⓞ button and the STROBO menu appears. You can switch-off (STOP) the stroboscope or change the step frequency tuning.

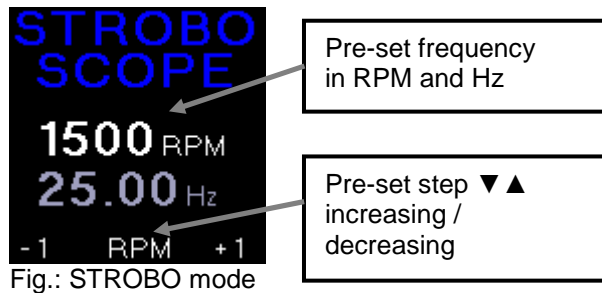

Fig.: STROBO mode

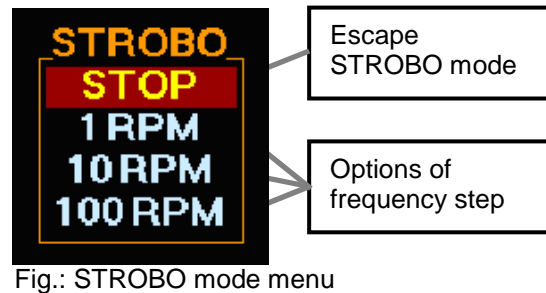

Fig.: STROBO mode menu

## VOLUME

The volume bars appear. The volume is changed by buttons ▼ ▲. When the maximum volume is reached, the symbol will become orange otherwise the amount of yellow filling shows the actual volume. If the earphones are off, the symbol is grey. Next press of the button Ⓞ returns the instrument back to the measurement mode.

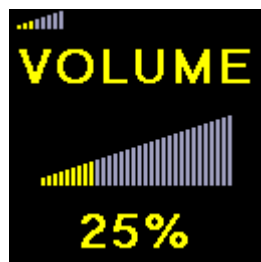

Fig.: Volume adjustment

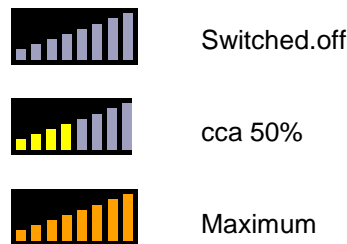

Fig.: Displayed volume

During the instrument is switched on or off, the range is changed, the sensor is connected or disconnected, the short unpleasant crack can be heard. This is not a defect of the instrument.

**Be careful not to overload the earphone amplifier by excessive volume. This will distort a signal in the earphones !**

You can use any **stereo** or **mono** headphones with nominal impedance higher than **8 Ω**. Both output stereo channels are connected to the signal.

**SETUP**

Further functions menu appeared.

Choose requested function using arrows and confirm by  $\text{Ⓢ}$  Enter.

**SPEED**

Switch on (AUTO ON) or switch off (AUTO OFF) automatic detection of RPM. The manual enter is required, when AUTO OFF.



For ver.2.05 and higher more options are available:

AUTO - automatic speed detection

MANUAL - always manual entry of speed

OFF - speed value is ignored, no limits with relation to speed are used.

### ALARMS

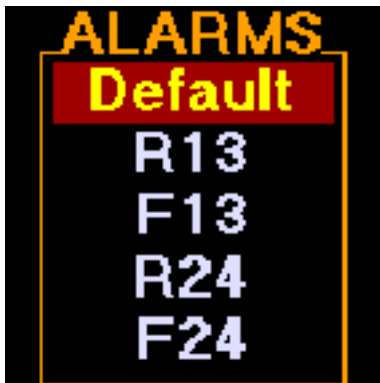

Standards setup, Alert limits (amber colour) and Danger (red colour) will be defined. See Standards for vibration measurements chapter.

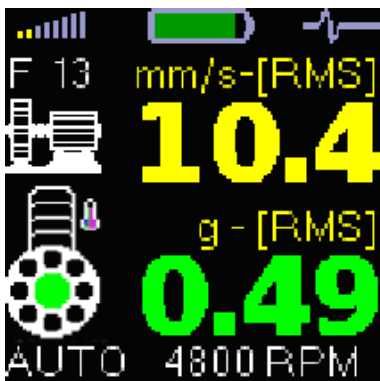

Chosen standard is displayed above the machine symbol (F13 in this case). If Adash standard is chosen, nothing is displayed.

### UNITS

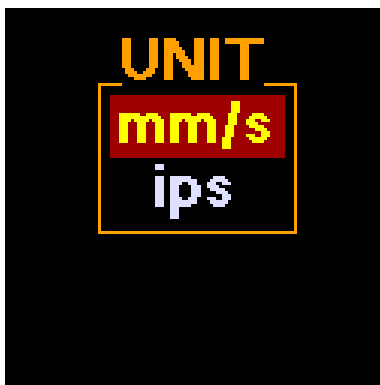

Vibration speed unit can be chosen here. mm/s (millimetres per second) and ips (inch per second) are available. Device remembers chosen unit even after switch off.

### -ESC-

Return to the MENU screen.

## Error Messages

### Sensor connection Error

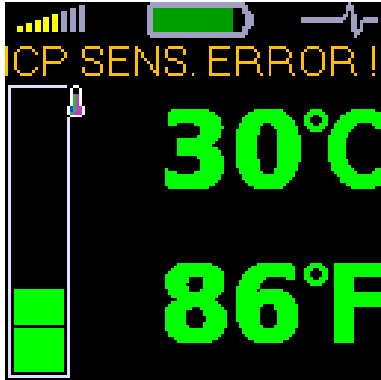

When incorrect connection of a sensor, unsuitable sensor type, broken cable etc. is detected, then the temperature screen occurs and the error message is written upon the values.

### Display Value Overload

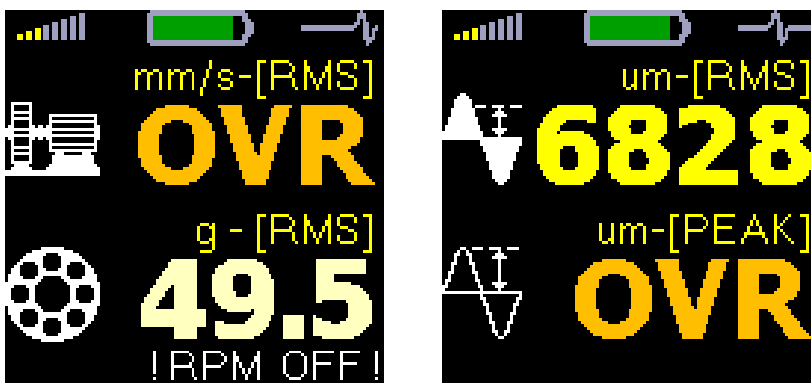

When the value exceeds the range of display, then OVR is displayed.

### Input Overload Error

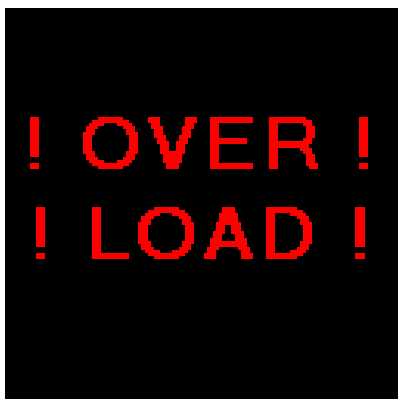

If an input signal is too strong (higher than 12V peak), the instrument cannot process it, the overload error is displayed. The instrument is not capable of measuring this signal.

### ***Measurement Error***

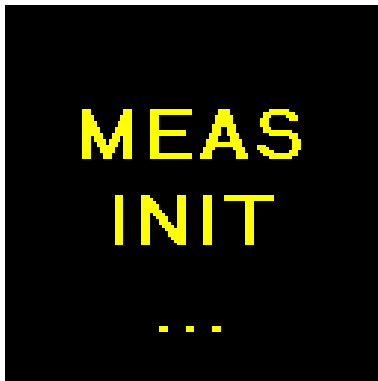

If there is a break in communication between measuring and display boards inside of the instrument, this measurement initialization error is displayed (MEAS INIT). If you see this error, it means that the instrument is malfunctioning and we recommend to send it to the manufacturer for repair.

## How to evaluate the failure

The instrument shows measurement results on several separate screens. We shall describe basic rules for their use.

### Overall RMS values

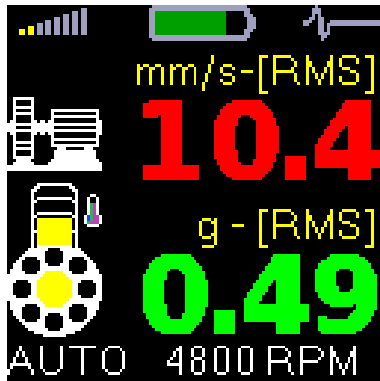

- Machine symbol - this line shows RMS velocity vibration value in mm/s or ips, which is excited on the machine by mechanical phenomena related to:

- imbalance of rotational parts of the machine (fan wheel, impeller, clutch wheel etc.),
- incorrect axis alignment of the assembly – misalignment,
- mechanical looseness of individual machine parts,
- large free play in seating of rotational machine parts (shaft - bearing, shaft – bearing housing),
- clutch free play (e.g. free play on a shaft, pressed out grooves and tongues),
- loose or worn out machine anchor bolts,
- defective base,
- insufficient frame or anchoring flange rigidity,
- damage to machine rotation parts - (bent shaft).





- Bearing symbol – this line shows RMS acceleration vibration value in g, which is excited by a condition of bearing. This condition is related to:

- time wear of the bearing,
- bad lubrication (with new bearings as well),
- incorrect installation (with new bearings as well),
- abrading of bearing.

The thermometer symbol is drawn together with the bearing. The temperature color is used according to the actual measured value.

**SPEED** - The machine speed is displayed at the bottom part of the screen (if it is available). RPM means revolutions per minute. The instrument performs automatic detection of machine revolutions using a spectrum analysis. This function does not have to be always successful, because the revolutions may not be possible to read for every spectrum. If the speed is not determined, it is not a malfunction. It is hard to do it, for example, in machines with gears.

If the speed is available, then  and  vibration values have been coloured corresponding to vibration limits. Machine conditions are divided into 3 levels, which have the same colours like traffic lights:

1.GOOD – GREEN COLOUR

Machine is in good condition, no defect is found. The operation is without restrictions.

## 2.ALERT - AMBER COLOUR

The beginning defect has been found on the machine. It is possible to operate with paying more attention and planning of repair.

## 3. DANGER – RED COLOUR

There is an serious defect found on the machine. Machine shouldn't be in operation

### Overall PEAK values

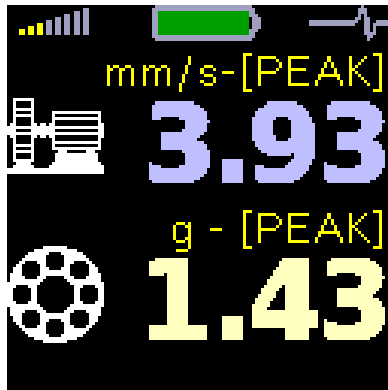

Similar rules for evaluation of the measured values, as in the previous screen are valid for this screen with one difference. The peak (PEAK) vibration values are displayed. It is highest measured value in certain time, which is important for transient shock events evaluation, especially in cases of incipient bearing defects, like:

- microscopic peeling off of a hardened surface layer in the place of a rolling element contact with a bearing ring (regular shocks),
- contamination of bearing space by metal particles (irregular shocks),
- cracks.

Shocks which cause these defects are also parts of the RMS vibration values. However, the peak value of such shock is hidden in a value which contains all other information about vibrations, i.e. noise from possible abrading, wrong lubrication and overloading. To simplify, the RMS is an average value of all vibration values achieved in certain time. If a large peak value (one shock) appears in this time period, it will be lost in the final recalculation of all the values.

This practically means that during increasing of this bearing defect that causes the shock, the PEAK value of this shock will visibly increase, while the effective (RMS) value will increase only slowly. We can discover the initial defect time of the bearing sooner. But PEAK value is not so stable as RMS value. For bearing condition measurement is the RMS measurement sufficient.

### Spectrum 200 Hz– Detection of Looseness

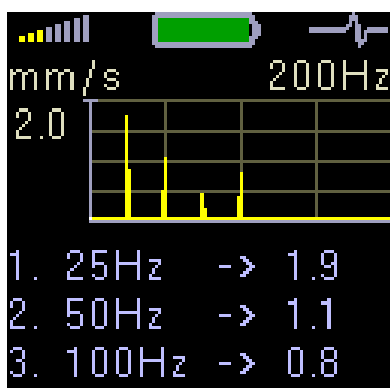

This screen is important for detection of the mechanical looseness. When the graph shows a number of lines (typically 3 or 4) with the same space between them and the first line is on the speed frequency (see the value description on the bottom) probably mechanical looseness is the machine problem.

The most common causes of this defect are:

- soft flanges,
- loose anchoring bolts,
- cracks in frames – cracked welds,
- free play in rotational part seating,
- or possibly other problems not related to mechanical looseness,
- bent shaft.

See also FASIT chapters.

### **Time signal for bearing condition evaluation**

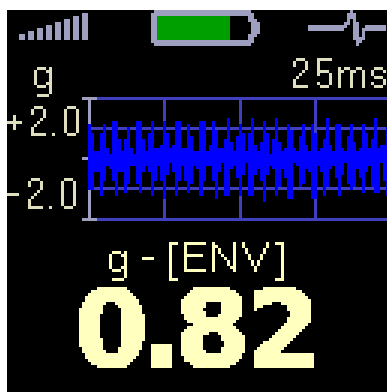

The time signal of bearing vibrations is displayed.  $g_{ENV}$  value is under the time signal (envelope modulated signal - see Methods for ball bearing condition diagnostics chapter. Caution – the time signal is displayed as a direct record, not after envelope modulation. Look at three basic screens for easy work with this function.

#### **Undamaged bearing:**

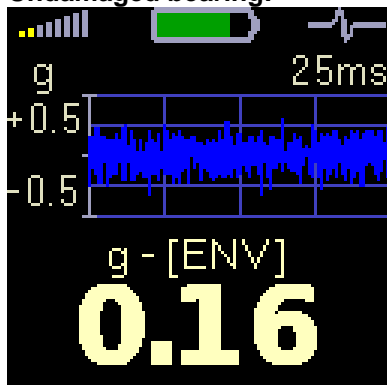

This bearing generates a low amplitude noise only, whose time record shape is steady. It's necessary to have a look on the range of the graph (left side). Signal could look high but it's not when the graph range is low (for instance 0,5 g).

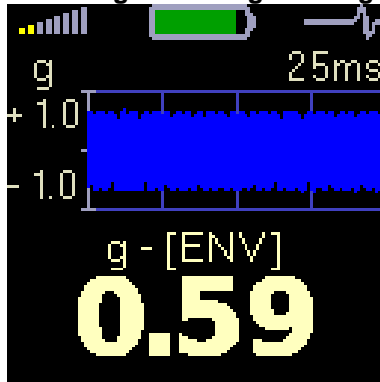
**Undamaged bearing – wrong lubrication:**

The time record shape is steady too but it has bigger amplitude than previous case. You can clearly see different (bigger) range of the graph (1,0 g)

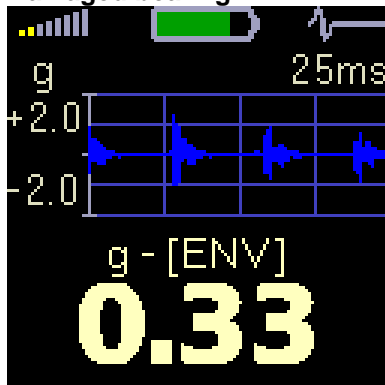
**Damaged bearing:**

There are clearly visible shocks caused by a rolling element coming across the damage like pitting or crack here. The shocks repeat themselves regularly. The range of the graph is different again (2,0 g in this case).

## Vibrations in frequency bands – gearboxes/bearings.

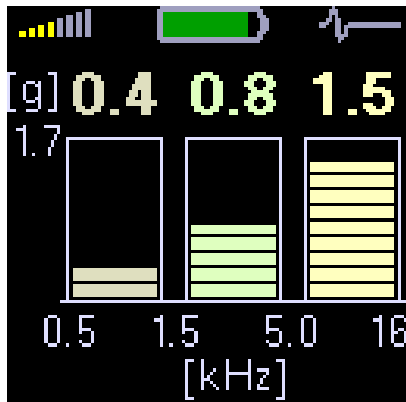

When we need to find the failure on not simple machines (e.g. gearbox) then it is very useful to know the vibration values in several frequency bands.

The screen No. 6 shows measurement acceleration values in three frequency bands: 0.5 – 1,5 kHz, 1.5 – 5 kHz and 5 kHz – 16 kHz.

### Example:

We are going to show the analysis procedure on a signal obtained on a seating of an inlet transmission shaft with the speed frequency 25 Hz (1500 rpm) and with a gear with 65 teeth. So called tooth frequency can be obtained by simple multiplication of the shaft revolution frequency (in Hz) by the number of teeth.

$$f_{\text{GMF}} = f_{\text{speed}} * Z$$

$f_{\text{GMF}}$  gear mesh frequency  
 $f_{\text{speed}}$  speed frequency  
 $Z$  number of teeth

In our example the tooth frequency is 1625 Hz (so approx. 1,6 kHz).

What are the possibilities?

**The transmission is OK** and tooth frequency of 1,6 kHz slightly increases vibrations in the second frequency band.

**Bearing failure** - vibrations are concentrated in the last frequency range 5 – 16 kHz

## Fault Source Identification and Diagnostics

Description of FASIT has been described in the beginning of this guide. This screen can be displayed behind the screen No.6 ( right arrow) or simply from the screen No.1 ( left arrow).

For correct evaluation the speed must be defined. The instrument can do it automatically or by user manual entry.

As it has been described in Screen No.1 section, the machine condition is divided into 3 levels, which have the same colours like traffic lights. The same approach we also use for fault detection.

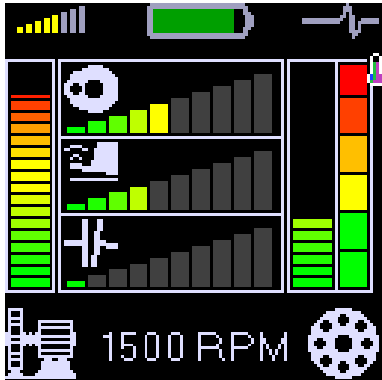

In the left bottom corner you see the Machine icon. The vertical bar displays the overall machine condition. This condition can be evocated by many reasons. The unit evaluates severity of 3 sources, which are the most occurred in the practice:

- Unbalance (circle with heavy spot icon),
- Looseness (shoe icon)
- Misalignment (clutch icon).

Correspondent faults horizontal bars are in middle.

On the right bottom corner you find the rolling bearing icon. The vertical bar displays the bearing condition. The meaning of Machine and Bearing bars was described in Screen No.1.

The temperature bar is displayed quite on right side. The ranges of colours are for less than 30°C - green, 30-45°C - yellow, 45-60°C - orange, 60-75°C - red and for greater than 75°C – dark red.

### What do the colours means in fault bars of machine and bearing?

#### GREEN COLOR

It may surprise somebody, because why to think about faults when the colour is green. But also from low level signal the procedure can read the beginning of the fault. But the operation is without restrictions.

#### AMBER COLOR

The beginning level of defect is found on the machine. It is possible to operate with paying more attention and planning of repair.

#### RED COLOR

There is the serious defect level found on the machine. Machine shouldn't be in operation.

## **Adash 4900 – Vibrio III Specifications**

**Input:** 1x ICP powered accelerometer  
**Input range:** 60g PEAK with standard 100mV/g sensor  
 (e.g.600g PEAK for 10mV/g sensor, the sensitivity is editable in the unit)

### **Measurements:**

<b>Detection</b>	<b>Unit</b>	<b>Frequency Range</b>	<b>Display</b>
RMS	mm/s, ips	10-1000 (opt.1-1000) Hz	0-999
PEAK	mm/s, ips	10-1000 (opt.1-1000) Hz	0-999
RMS	g	500-16000 Hz	0-999
RMS	g	1500-16000 Hz	0-999
RMS	g	5000-16000 Hz	0-999
RMS	um, mil	2-200 Hz	0-999
PEAK	um, mil	2-200 Hz	0-999
Time Signal	g	500-16000 Hz	0-999
Spectrum (200 lines)	mm/s, ips	4-200Hz	0-999
Temperature	°C, °F		0-380°C (32-716°F)

**Display:** colour OLED display 128 x 128 pixels, diagonal 1.5" (38mm)

**Further functions:** LED stroboscope (0.17 Hz – 300 Hz, 10 RPM – 18000 RPM)  
LED torch

**Output:** 1x AC signal 8  $\Omega$  / 0,5 W for external headphones (signal listening)

**Power:** 2xAA 1.5V batteries (alkaline, NiMH, LiFe)

**Temp:** Operating: -5 to 50, Storage: -20 to 65 (Degrees Celsius)

**Dimensions:** 150 x 60 x 35 mm

**Weight:** 350 g including batteries (without cable, sensor and magnet)  
540 g including batteries, cable, sensor and magnet

**Accessories:** vibration sensor, coiled cable to connect vibration sensor, magnetic base for vibration sensor, earphones, recording cable with 3.5 mm jacks, measuring tip for manual pressure on the sensor, 1.5V alkaline batteries, transport case, CD with the manual

## **Response specification**

Adash 4900 - Vibrio III

### ***Vibration velocity measurement frequency response***

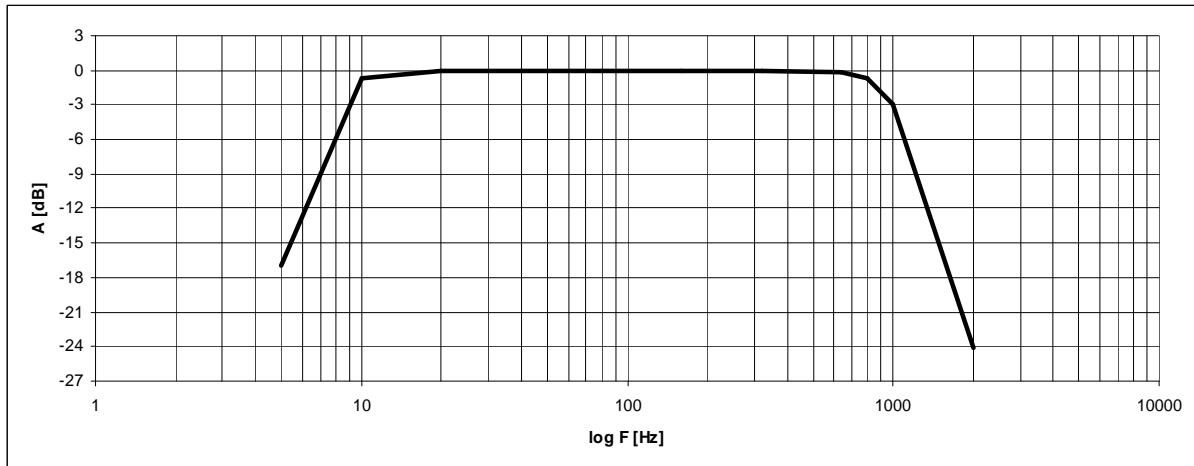

Measurement accuracy (10 mm/s RMS input signal) is +/- 2,5 % (5-500 Hz frequency range) and +/- 5% (500 – 2000 Hz range).

### ***Vibration acceleration measurement frequency response***

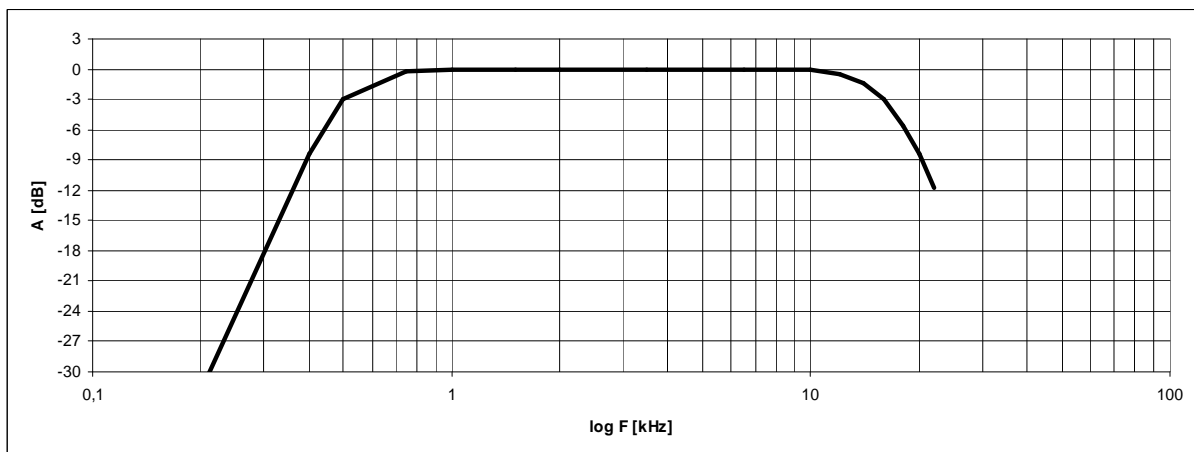

Measurement accuracy (1 g RMS input signal) is +/- 2,5 % in 0,2 -20 kHz frequency range.

### ***Velocity measurement amplitude response***

Measurement accuracy for RMS vibration velocity (0,1 – 100 mm/s range) on 80 Hz reference frequency is +/- 2,5 %

### ***Acceleration measurement amplitude response***

Measurement accuracy for RMS vibration acceleration (0,1 – 10 g range) on 8kHz reference frequency is +/- 2,5 %

## **Calibration recommendations**

### **Sensor sensitivity**

Before any calibration you need to know, what exact sensitivity of sensor is set in the instrument. See the initial screen, which contains this information.



#### **Description of numbers in initial screen:**

1. The sensor sensitivity mV/g times 10 ( 983 means 98,3mV/g)
2. Firmware version ( V2.05dtH)
3. HP filter frequency for bearing in kHz ( 0,5 kHz)

The sensor sensitivity is not equal 100mV/g very often. The sensitivity of sensor is usually in 95-105 mV/g range. Let suppose the sensitivity which is set in the instrument is equal **S**. Then all calibration measurements, which are adjusted to the sensitivity 100mV/g must be multiplied by **100/S**.

### **Basic test with A4801 Sensor Simulator**

If you have the A4801 unit, you can regularly test the unit on two frequencies 80Hz and 8kHz. On the initial A4900 screen are displayed RMS values of velocity and acceleration. The velocity value should be 10 mm/s and the acceleration should be 0.5g.

The signal from A4801 is adjusted for exact 100mV/g sensitivity. When the sensitivity of A4900 unit is e.g. 95mV/g, then the higher values (10.5mm/s and 0.53g) will be displayed. Expected values from the A4801 should be multiplied by 100/95 coefficient.

### **Basic test with sensor and shaker**

The procedure should be the same as with A4801. Set on the shaker 10mm/s on 80Hz and check the RMS velocity value on the initial screen. Then set 0.5g on 8kHz and check the RMS acceleration. If you have trouble to generate the 8kHz, you can use lower frequency, but not lower than 1200Hz. Below this limit the LP filtering is applied and the result would be distorted.

### **Advanced tests of velocity measurement**

Use the shaker and sensor. You can make the frequency response and the amplitude response.

Use the amplitude 10mm/s for frequency response test. Change the frequency from 6 to 1200 Hz and check the filtration curve, which is drawn in previous chapter. Also the accuracy is mentioned there.

Set the 80Hz for amplitude response. Change the amplitude from 0.1 to 100 mm/s and check the accuracy (+/- 2.5%).

**Advanced tests of acceleration measurement**

Use the shaker and sensor if you are able to shake high frequencies (10kHz or more). If your shaker system does not allowed it, use the signal generator and switch the ICP off. Contact your re-seller for information, how to switch the ICP off. That information is not written in this manual.

You can make the frequency response and the amplitude response.

Use the amplitude 1g for frequency response test. Change the frequency from 500 to 12000 Hz and check the filtration curve, which is drawn in previous chapter. The accuracy is +/-2.5%.

Set the 8kHz for amplitude response. Change the amplitude from 0.1 to 10g and check the accuracy (+/- 2.5%).

**Envelope demodulation test**

The envelope value is RMS value. Do not use comparing with peak values. Use the 8kHz pure sine signal with 1g (100mV) amplitude. The ENV should display 1.33g +/- 2.5%.